

hoxter

BLOX

Accumulation stove







Accumulation stove

The increased quality of building technology requires heating technology to change along with it. Today's homes often have a well-insulated building envelope and require a different approach. Unlike massive heaters that quickly burn out and require constant refuelling, the BLOX compact accumulation stove comes with a different philosophy. The heat output is limited and is designed for better heat accumulation with fewer fuelling intervals. The basic modular stove body is made of exposed concrete with a clear view of the fire, using the reserve of the accumulation mass while maintaining a compact size. The stove stays warm for a long time after the fire has gone out. The design also prioritises quick assembly and quality of detail. Design and functionality come together in a symbiosis of simple form and high-quality stove craftsmanship.

Refuelling intervals and heat discharge

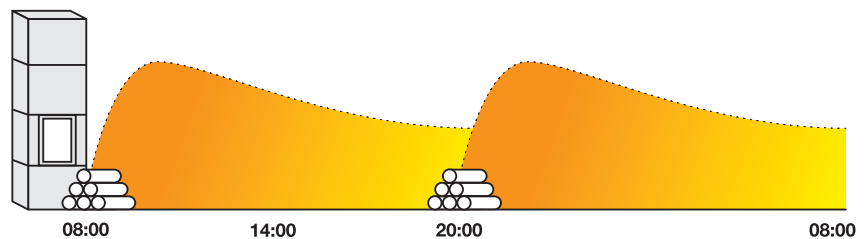

BLOX accumulation stove

A robust design in a compact size



Heat accumulation in a closed casing

The stove casing is completely closed with no air convection holes, resulting in the longest possible heat accumulation and the lowest possible hourly heat output. The accumulation process is powered by the double-walled accumulation rings in direct contact with the flue gas. At the beginning of the heating process, the heat enters the room through the glass door. This is then replaced by radiant heat from the entire surface of the stove housing.

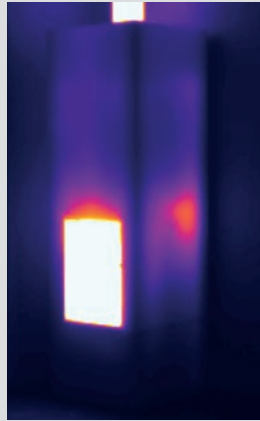

1 hour after heating
Average surface
temperature 29 °C



3 hours after heating
Average surface
temperature 88 °C



12 hours after heating
Average surface
temperature 45 °C

Accumulation ring

- Spiral flue gas duct
- Bulk density 2,700 kg/m³
- Production firing temperature 1,100 °C
- Connection via sealing rope with tongue/groove system



3 + 3 kg
Batch of wood

12 hours
Heat output duration
after heating

1,6 kW/h
Average heat output

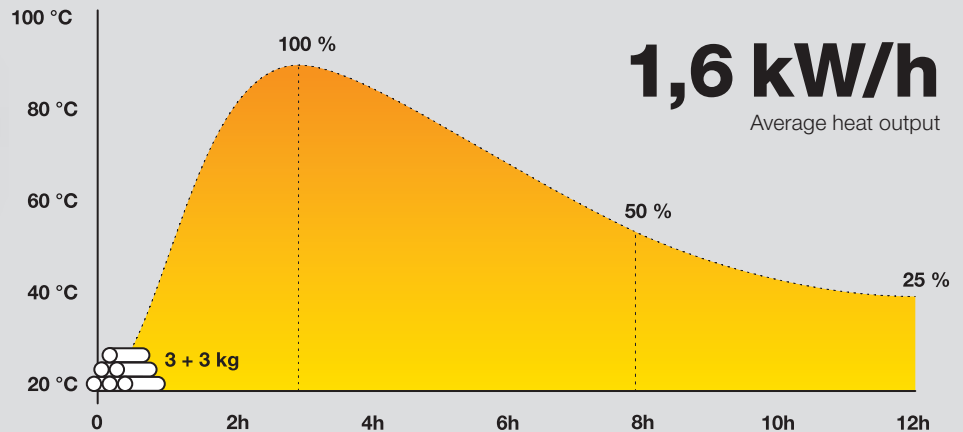

Change in average surface temperature relative to room temperature

Design flexibility



Square or round?

The BLOX accumulation stove is available in two shapes, square or round. Both variants have the same internal heating technology and identical technical parameters.

5 mm

Frame thickness



A stable door profile

The door profile has a wall thickness of 2.5 mm and is made of boiler steel to guarantee permanent stability at high temperatures. The tapered shape of the groove seals to the body to prevent spillage. Single or double glazed doors are available with hinges on the right or left.

Handles and air controls

Small details such as the handles and air controls are part of your stove's appearance. Two designs combine stainless steel and black in two finishes. The black version is made by applying Teflon to the stainless steel for high durability.

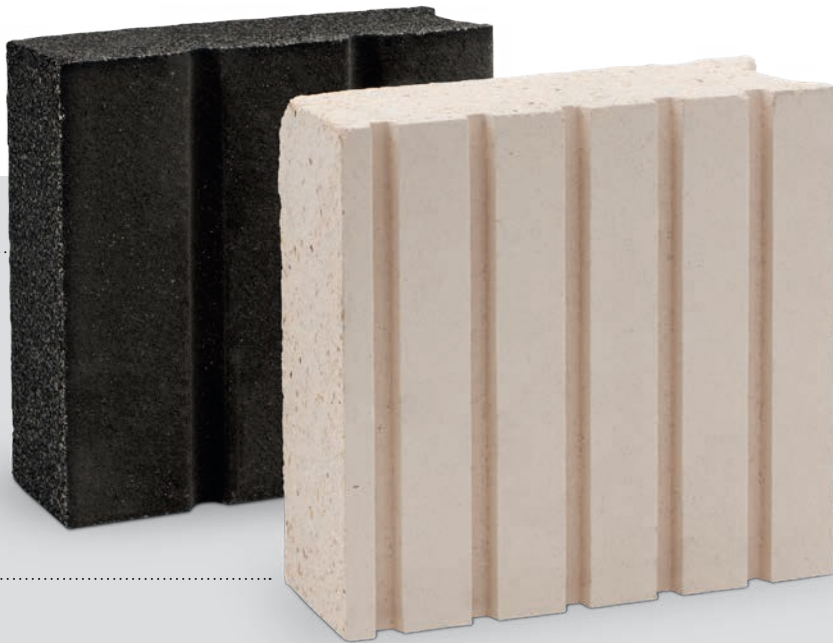
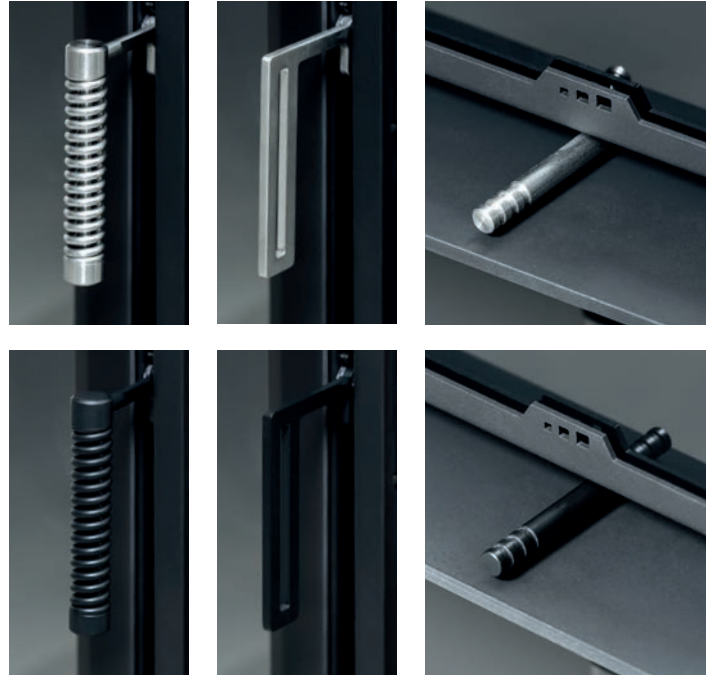

Firebox lining

You can select either the standard light-coloured firebox lining or a dark lining. Both linings are fired at 1,100 °C and the dark version is made of a full-colour blend.

Quick installation

During the design process, we prioritised the most important elements: fast installation, connection variability, and a guaranteed long-term service life for the entire stove. This is attested to by the combination of materials used and the modular system of the entire product.



3–5 hours

Installation time

6 pcs

Concrete parts

425 kgs

Total weight

3–5 hours

Installation time

7 pcs

Concrete parts

415 kgs

Total weight

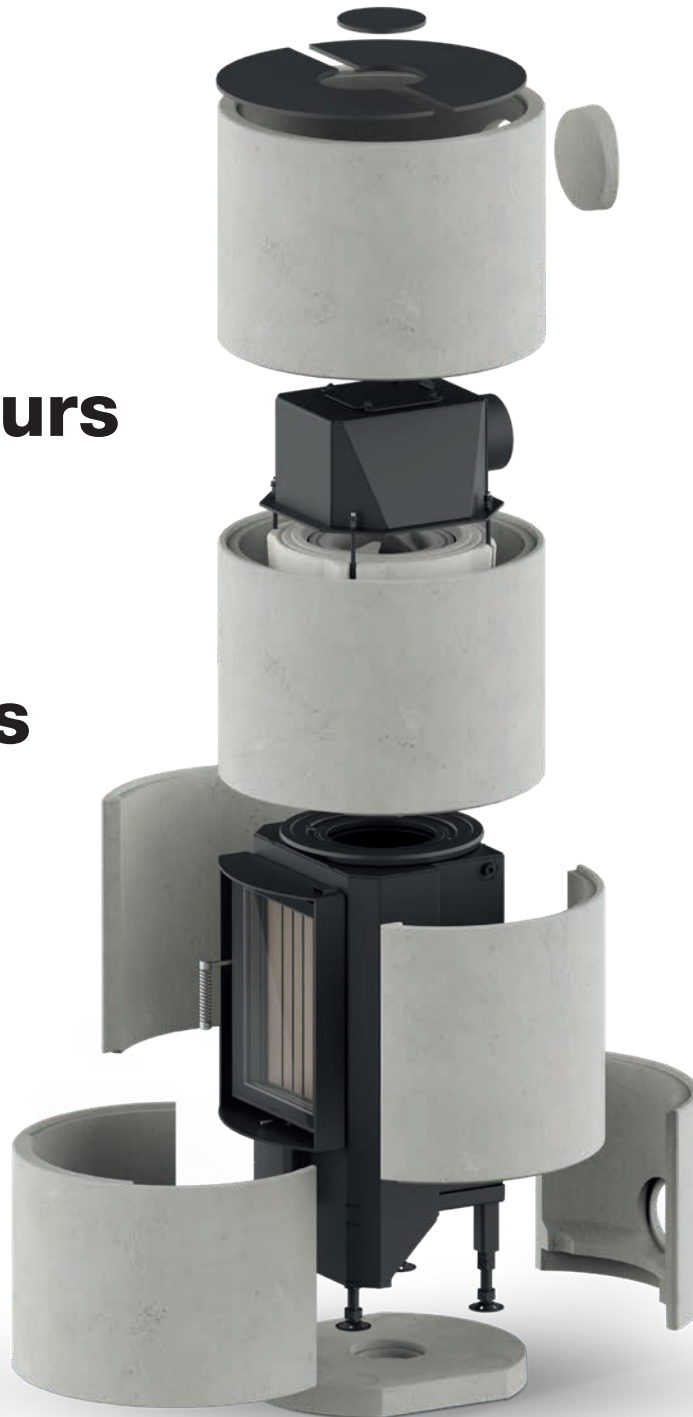

Surface repair kit

The accumulation stove is delivered with a concrete surface repair filler kit in the event of minor damage during handling and installation.

Variable connection

Smoke outlet

The flue gas outlet from the stove type BLOX 50 can be directed to the top ($\varnothing 130 / \varnothing 150$ mm) or to the rear ($\varnothing 130$ mm). The upper part with gas outlet opening can be optionally turned in 90° direction (to the side).

BLOX R55 allows the flue gas outlet to be directed to the top or to the rear ($\varnothing 130 / \varnothing 150$ mm). The upper part can be turned in any direction.

The unused venting duct serves as an inspection opening.



Air inlet

The air required for combustion in the firebox can be connected from the rear ($\varnothing 100$ mm) or from the bottom ($\varnothing 100$ mm). The split bottom of the housing allows convenient access for connecting the aluminium hose.

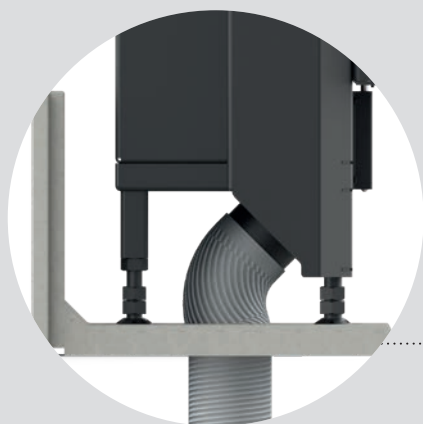

Exposed concrete

The surface of the exposed concrete is typically unevenly coloured and may contain surface hairline cracks. The concrete casing can be painted or plastered for optimal solid look. For this purpose we recommend to use the HOXTER Concrete paint for fireplaces.

Detail of the natural
concrete surface



HOXTER Concrete
paint for fireplaces



Individual surface finish
with suitable white paint

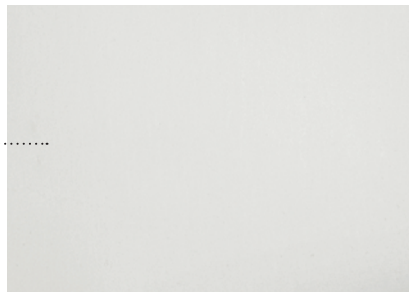

For wooden and passive homes

Our primary objective was to create an attractive, compact heat source for houses and rooms with low heat loss. For the popular wooden house constructions, we have designed a system of external and internal thermal shielding for our accumulation stoves to achieve minimum spacing from combustible walls.

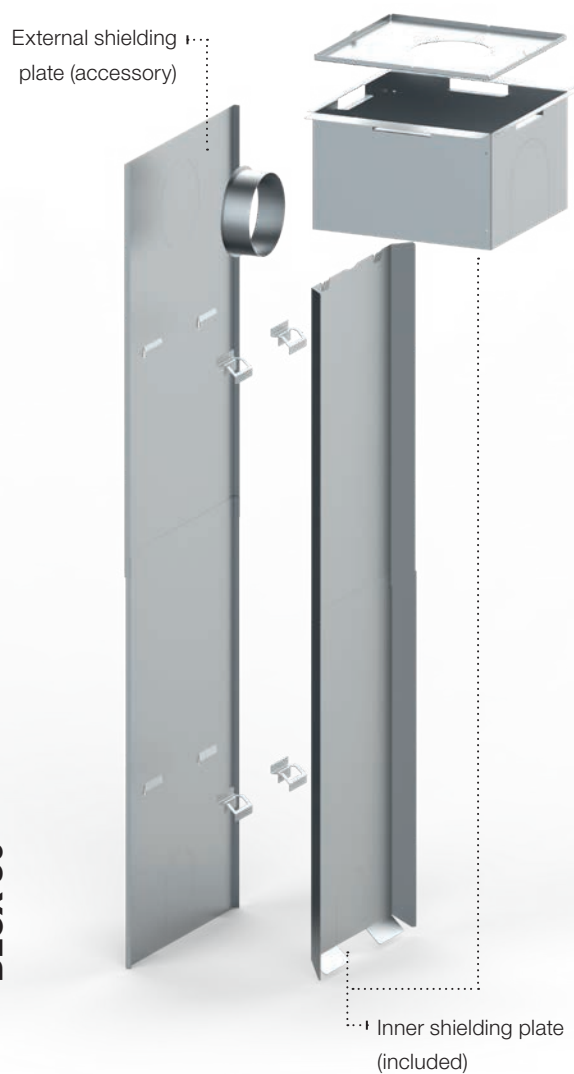

Minimum spacing for walls made of non-combustible materials

· solid brick, concrete, aerated concrete

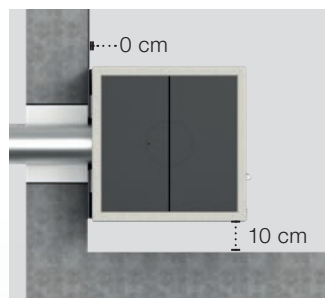

With external shielding plate (accessory)

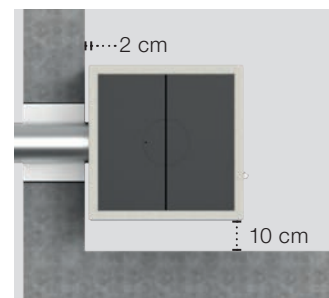

Without external shielding sheet

Minimum spacing for walls made of combustible materials

· wooden structures, load-bearing walls up to 10 cm thick

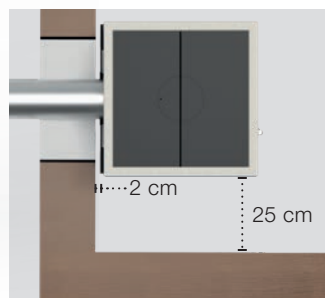

With external shielding plate (accessory)

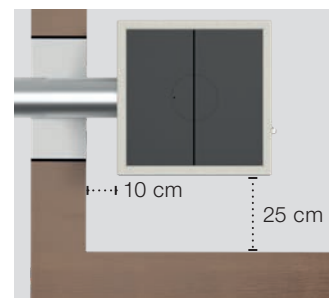

Without external shielding sheet

Minimum spacing for walls made of non-combustible materials

· solid brick, concrete, aerated concrete

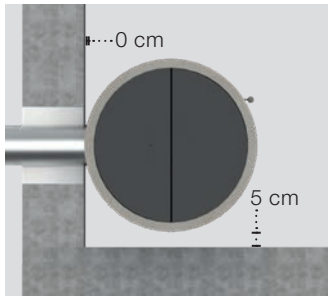

Without external shielding sheet
(placement against the wall)

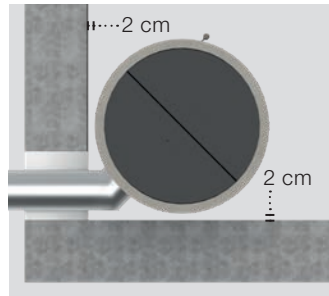

Without external shielding sheet
(placement to the corner)

Minimum spacing for walls made of combustible materials

· wooden structures, load-bearing walls up to 10 cm thick

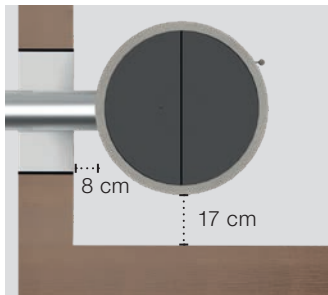

Without external shielding sheet
(placement against the wall)

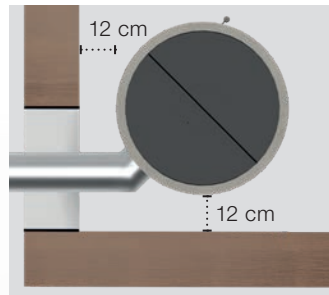

Without external shielding sheet
(placement to the corner)

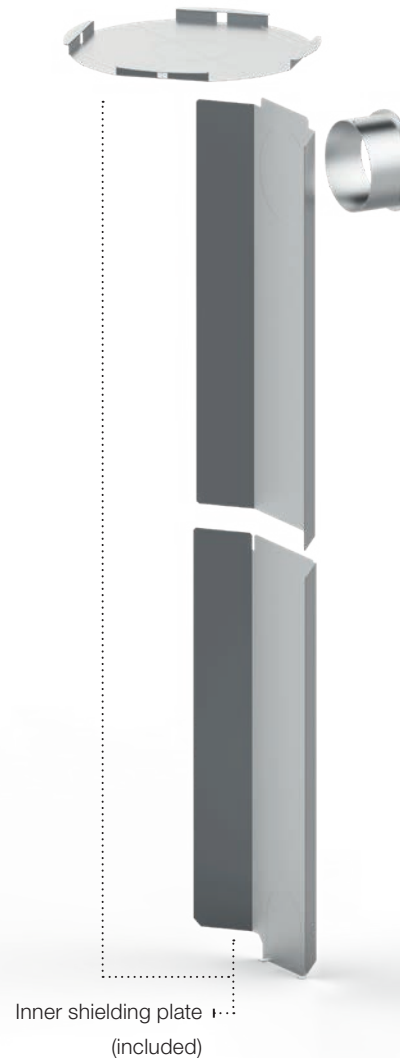



Technical data

	BLOX 50		BLOX R55	
	Values according to EN 13240	Accumulation operation measured values	Values according to EN 13240	Accumulation operation measured values
Energy label	A+		A+	
Operating data				
Nominal power	12 kW	-	12 kW	-
Efficiency	> 80 %	> 80 %	> 80 %	> 80 %
Refuelling turnover	3,3 kg/h	6 kg (3 + 3kg)	3,3 kg/h	6 kg (3 + 3kg)
Average heat output	-	1,6 kW	-	1,6 kW
Heat output time ¹	-	12 hours	-	12 hours
Mass flow of flue gases	11 g/s	11 g/s	11 g/s	11 g/s
Required chimney draft	12 Pa	12 Pa	12 Pa	12 Pa
General technical information				
Total weight	425 kg		415 kg	
Overall dimensions (width × depth × height)	500 × 500 × 1597 mm		Ø550 mm × 1647 mm	
Dimensions of the firebox (width × depth)	250 × 210 mm		250 × 210 mm	
Diameter of the combustion air inlet	backwards Ø100 mm / downwards Ø100 mm		backwards Ø100 mm / downwards Ø100 mm	
Diameter of the flue connection	backwards Ø130 mm / upwards Ø130 mm (Ø150 mm)		backwards Ø130 mm (Ø150 mm) / upwards Ø130 mm (Ø150 mm)	

1) Time from heating to 25 % of the maximum average surface temperature relative to the room temperature

Upcoming models

Within a single season the BLOX accumulation stoves has become a very popular product in the portfolio. That's why we decided to expand the BLOX system with new models - modular fireplaces. New models will offer traditional front, tunnel, corner and three-sided glazing and also the possibility of convection or accumulation operation mode.



BLOX H60



BLOX H84



BLOX E75



BLOX H60T



BLOX H84T



BLOX U75

Hoxter a.s.

Jinačovice 512
66434 Jinačovice
Czech Republic
Tel.: +420 518 777 701
E-mail: info@hoxter.eu

Version 02/2024
EN-M1000473

www.hoxter.eu

Hoxter GmbH

Haidmühlweg 5
92665 Altenstadt an der Waldnaab
Deutschland
Tel.: +49(0)9602 944 7944
E-mail: info@hoxter.de